



**BENNETT MARINE**



# AutoTrimPro

All-in-one trim tab control system

Installation & User's Guide

For Electric Trim Tab Systems

**IMPORTANT SAFETY INSTRUCTIONS:** Read and follow all instructions. Keep this manual on your boat.

# Congrats!



---

Congratulations on your purchase! We're proud to say, boaters trust our brand. After all, we invented the world's first adjustable trim tab—and never stopped pushing forward, always striving to make a better, more affordable system with maximum performance.

---

## Behind You For The Distance

Bennett's legendary customer service and support is a priceless perk to your new purchase! Our expert staff with over 50 years of trim tab experience is ready to assist with your installation, help with troubleshooting, or answer any of your questions along the way.

## How to Contact Us

Call us at 1-954-427-1400, email [Info@BennettTrimTabs.com](mailto:Info@BennettTrimTabs.com), or go to [BennettTrimTabs.com/Contact](https://BennettTrimTabs.com/Contact) and fill out the online form. Please allow 24 hours for online requests. Our office hours are Monday through Friday from 8:00 a.m. to 5:00 p.m. (Eastern Standard Time).

## The Benefits of Trim Tabs

**Increase Visibility For A Safer Ride:** Keeping your bow down at reduced speeds is important, especially in congested waters or foul weather. Bennett trim tabs enable you to plane at a much lower speed, operating your boat more safely.

**Save Money With Better Fuel Efficiency:** Getting up on plane quicker means your boat spends less time running inefficiently. Bennett trim tabs decrease engine laboring, dramatically improving your fuel economy and prolonging the life of the engine.

**Maximize Performance While Smoothing Out The Ride:** Bennett trim tabs enhance the operating economy of your boat by lifting the stern in proportion to speed, weight distribution, and fuel load changes.

# Contents

Contacting Us .....	2
<b>System Overview</b>	
System Overview .....	4
System Components .....	5
<b>Planning and Installation</b>	
Planning the Installation .....	6
Installation of System Components .....	8
ATP Helm Display Drilling Templates .....	11
System Wiring Diagram .....	13
<b>System Set-up</b>	
Angle Calibration.....	14
Auto Mode Set-up (Favorite Buttons) .....	16
<b>Trim Tab Basics</b>	
How Trim Tabs Work.....	20
Special Conditions & Safety .....	22
<b>AutoTrim Pro Operation</b>	
ATP Helm Display Quickstart Guide.....	24
Indication & Manual Mode Buttons .....	25
Semi-Automatic Controls .....	27
Using Automatic Modes .....	29
Understanding Automatic Operation .....	31
<b>Troubleshooting</b> .....	36
<b>Warranty</b> .....	45

# System Overview

---



## **AutoTrim *Pro***

All-in-one trim tab control system

The Bennett ATP control is designed to enhance the boating experience by taking control of the trim tab operations during the time that the user is operating the boat.

Proper installation of the system components is critical for safe and optimal operation of the system. The electric ATP control works with all standard Bennett Marine trim electric tab systems and many other electric trim tab systems. The ATP is a complete control system and does not require any other user interface. Manual control, automatic control, trim tab position indication, and automatic trim tab retraction features are all integrated into the ATP system's Helm Display.

The ATP control is the “brains” of the system. The ATP control will constantly measure and monitor the boat's pitch and roll attitude, then operate the trim tab actuators. Because the ATP is truly a control, the ATP can be combined with the appropriate power switching device and can control many commercially available electric trim tab systems, thus adding a high degree of usability to any system.

# System Components

AutoTrim Pro  
Helm Display



AutoTrim  
Pro Kit Part#:  
AP000A1BC

AutoTrim Pro  
Control Unit

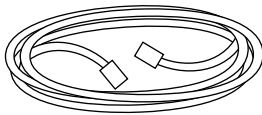

25' Helm Display  
Extension

The AutoTrim Pro (ATP) is an all-in-one trim tab control system consisting of two components, the Helm Display and the Control Unit.

*Please refer to the system diagram on page 13 for detailed system wiring requirements. For detailed information on actuators, trim tabs, and other components, please refer to the trim tab information that was provided with your trim tabs, or visit [BennettTrimTabs.com/Installation](http://BennettTrimTabs.com/Installation).*

**⚠ Is your system already installed? Please skip to page 24 to learn how to use your AutoTrim Pro. Enjoy the Ride!**

# Planning The Installation

---

## Getting Started

Installation of the ATP control system will assume that the installation of the trim tabs, actuators, and wiring has been completed according to the corresponding trim tab installation and users guides which can be downloaded at [BennettTrimTabs.com/Installation](http://BennettTrimTabs.com/Installation).

The ATP control system contains the following basic items.

1. ATP Helm Display
2. ATP Control Unit
3. Hardware and Cables

*Additional components may be required for more complex systems. Please call Bennett Marine at (954) 427-1400 with any questions.*

## ATP Helm Display

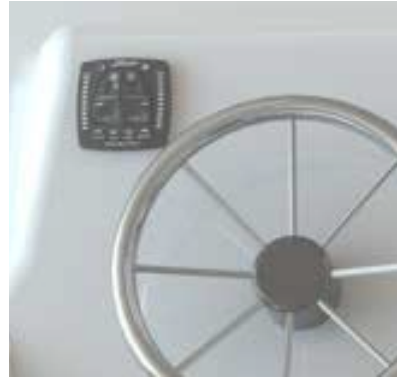

Locate an appropriate location on the helm for the ATP Helm Display. The ATP Helm Display should be installed such that the vessel operator has a clear, unobstructed view of the display, and is easily reachable from the operating position. Ideally, the ATP Helm Display should be installed in a horizontal position. This makes the use of the control more intuitive. It is important for the vessel operator to be able to clearly see the LED indicators on the ATP Helm Display to know what the ATP is doing. Before installing the ATP Helm Display, check for obstructions on the underside of the helm.

See page 8 for detailed installation instructions.

## ATP Control Unit



The ATP control unit must be mounted horizontally and parallel with the keel of the boat. The label indicates with an arrow which end should be oriented towards the bow of the boat. The location of the ATP control unit within the boat is not critical, but the orientation of the ATP control unit to the boat is very important.

The ATP Control Unit should be mounted on a rigid structure in the boat, and should not be mounted within 24" of any magnetic items such as electric motors or speakers.

See page 9 for detailed installation instructions.

**⚠ The Bennett AutoTrim Pro is not backwards compatible to existing control systems,** meaning the ATP control system replaces all BOLT Rocker Switch controls and all Indicator Controls.

# Installation of System Components

*Before starting any work, disconnect the battery(s), and verify that all power is turned off.*

## ATP Helm Display



1. Use the template included on Page 11 to help decide the location for the ATP Helm Display. The Helm Display should be located on the helm in view of the operator, and within easy reach. It is important for the vessel operator to be able to clearly see the LED indicators on the ATP Helm Display to know what the ATP is doing. Before installing the ATP Helm Display, check for obstructions on the underside of the helm.
  2. Drill the center hole 1" using the template from page 11
  3. Drill the four screw holes 3/16"
  4. Thread the wires for the ATP Helm Display through the 1" hole
  5. Secure the ATP Helm Display
- using the four 8-32 nylon thumb nuts included.
6. Locate the power source for all of the helm instrumentation. Connect the orange wire from the ATP Helm Display to the power source for the instrumentation. When power is removed from the orange wire, the system will shut down.
  7. Locate the ignition power. Consult the engine manufacturer's documentation to identify a source for ignition power. Connect the purple wire from the ATP display to the ignition power. The ATP Helm Display does not use any power from the ignition system, but senses when the power to the ignition has been turned off to automatically raise the trim tabs.  
**Note:** The orange and purple wire cannot be connected to the same source. **If the orange wire is connected to the ignition, the auto tab retract feature will not function.**
  8. Locate a suitable ground. Connect the black wire from the ATP Helm Display to the ground source for the instrumentation.

If a second helm station is utilized in this system, repeat steps 1-5 only for the upper station ATP Helm Display.



# Installation of System Components

## ATP Control Unit



The ATP Control Unit is the sensor and processor for the ATP system. The ATP Control Unit contains an accelerometer, gyroscope, and an electronic compass that sense the position of the boat, and the accelerations and decelerations that the boat is moving through. **The ATP Control Unit must be properly oriented on the boat to correctly interpret acceleration and deceleration.**

1. Locate a suitable dry location for the ATP Control Unit.
2. Position the control unit such that the arrow label on the Control Unit is parallel to the keel of the boat and pointed towards the bow. The the above graphic. The direction of installation is important so that the internal accelerometer and gyroscope are oriented properly with the vessel. If a suitable size flat surface cannot be located, Bennett Marine offers a vertical mounting bracket that will provide the flat surface.
3. Mount the Control Unit using the two #8 x 1/2" screws provided.
4. Connect the orange and black power wires to a power source

capable of supplying 20 Amps @ 12V or 10 Amps at 24V. (Refer to systems diagrams beginning on page 13)

## Connecting the system

1. Connect the communications cable from the ATP Helm Display to the communications cable on the ATP Control Unit.
2. Connect the port actuator cable to the blue and yellow cable (with the red tag) on the ATP Control Unit.
3. Connect the stbd. actuator cable to the blue and yellow cable (with the green band) on the ATP Control Unit.

## Testing the system

1. Reconnect the battery(s) or turn the battery switch to ON.
2. Turn the ignition to the ON position.
3. The ATP Helm Display should illuminate

*Continued on page 10*

# Installation of System Components

- The two blue LEDs over FAV1 and FAV2 should be flashing. This is an indication that the system has not been oriented to the boat.

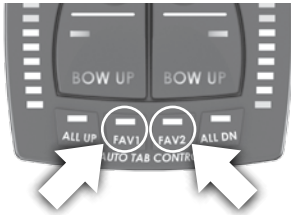

- Press the PORT Bow DN button on the ATP Helm Display. The



Starboard actuator should extend. If the Starboard actuator does not extend, or the PORT actuator extends instead of the Starboard actuator, refer to the troubleshooting section.

- Press the STBD Bow DN button on the ATP Helm Display. The



PORT actuator should extend. If the PORT actuator does not extend, or the STBD actuator extends instead of the PORT actuator, refer to the troubleshooting section.



# ATP Helm Display Drilling Template

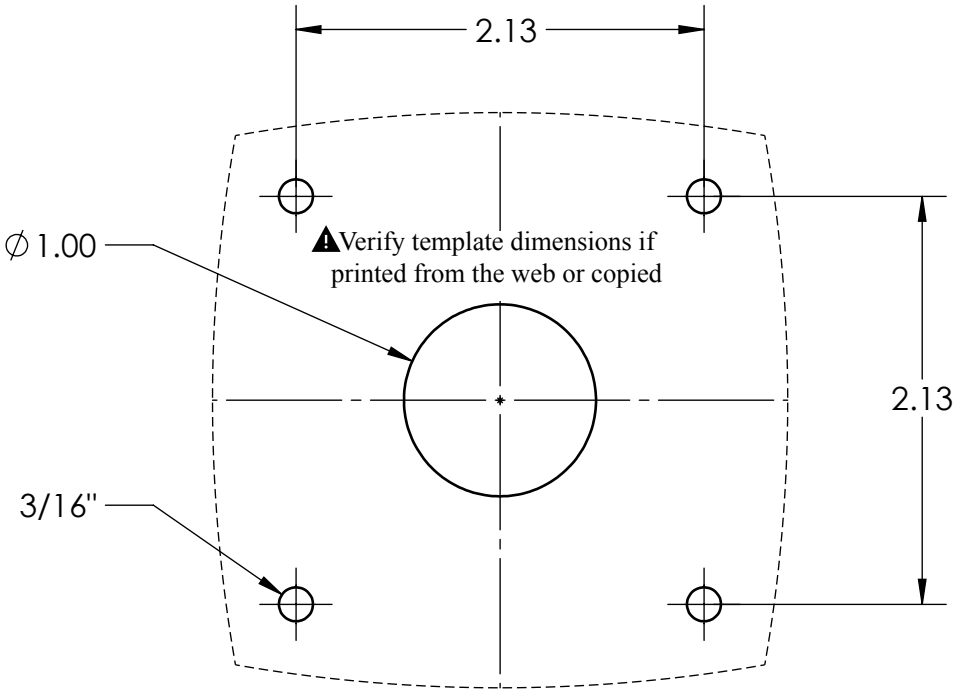

**Must be printed or copied at 100% scale**

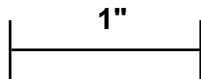



# System Wiring Diagram

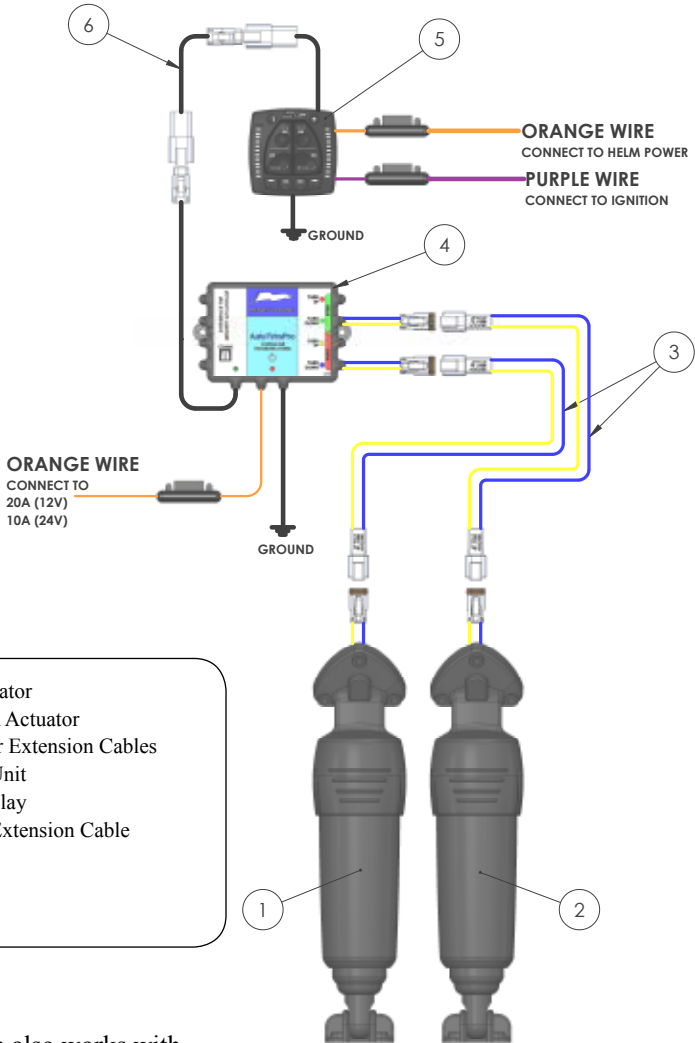

1. Port Actuator
2. Starboard Actuator
3. \*Actuator Extension Cables
4. Control Unit
5. ATP Display
6. Display Extension Cable

**\*Optional**

This diagram also works with Lenco Marine actuators

## Single Helm Display, Single Actuators

*Please call us at (954) 427-1400 for additional help with wiring instructions*

# System Set-up

*These steps cannot be completed until the boat is launched*

## Angle Set-up

The ATP system will evaluate the vessel's pitch angle to determine the mode the boat is operating in. In order to properly measure the pitch and roll attitude of the boat, the ATP Control Unit must be oriented to the boat.

### 1. Orient the system to the boat.

- Launch the boat.
- Turn the system on.
- Allow the boat to come to a rest.
- Press and hold the Moon and ALL UP buttons for three seconds.

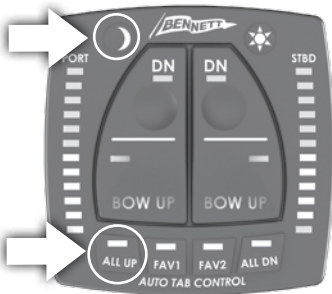

This will set the resting position of the boat and allow the system to retract the trim tabs any time that the system detects the boat is at rest.

The system will flash all four corner LEDs to indicate that a setting has been made.

### 2. Idle Angle Set-up

The idle angle is used to determine that the vessel is in a slow moving state. Trim tabs should be fully retracted any time the vessel is moving at idle speed as trim tabs will have no effect without water pressure against them. The idle angle should be set in calm water with the trim tabs fully retracted, and the vessel idling at a fast idle speed, usually about 1500rpm-2000rpm. The boat should be throwing the largest wake that would be acceptable in a NO WAKE zone. To set the idle angle, get the boat moving at an appropriate idle speed, run the boat at this speed for 10-15 seconds to allow the boat to settle. After settling, press and hold the moon button and the FAV1 button at the same time for at least 5 seconds.

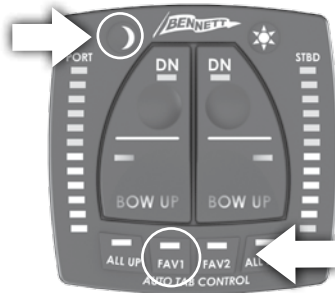

During the time the buttons are being held, the system is continuously taking measurements. The system will use the average of all the measurements that were taken while

both buttons are held. The system will flash all four corner LEDs to indicate that a setting has been made.

### 3. Planing Angle Set-up

The planing angle is used to determine that the vessel is on plane. The trim tabs will be deployed to varying degrees while the boat is planing to improve the boat's attitude in roll and pitch. The planing angle is not the target position that the boat will be maintained at, rather it is an identifier to tell the system that the boat is in the planing mode. If the boat's pitch angle drops below the planing angle, the system will automatically retract the tabs. If the boat's pitch angle is above the planing angle, the system will automatically control the trim tabs. The planing angle should be set in relatively calm water.

Put the trim tabs to a full-down position and carefully run the boat at it's fastest safe speed to set the planing angle. When the boat has settled into a steady pitch position

and a steady speed, press and hold the Moon and FAV2 buttons for 5

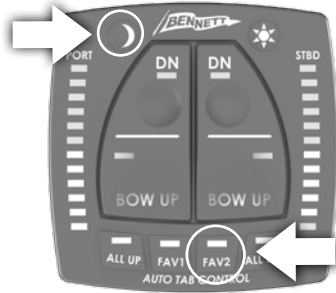

seconds. Allow another 15 seconds to let the system settle. This will set the planing angle.

The system will flash all four corner LEDs to indicate that a setting has been made.

**⚠ Caution:** The boat may be temporarily very over-trimmed in this attitude and have a potential to bow steer during the set-up only.

This is not the target position, but rather the limits of the operation range of the trim tabs.

## Favorite Position Set-up

The FAV1 and FAV2 buttons on the control are stored pitch and roll positions that the system will try to maintain the boat at the stored positions by adjusting the trim tabs accordingly. To set a favorite position, use the manual trim tab controls (and any other preferred means such as engine tilt or throttle controls) to get the boat into the attitude that you want the boat to run at.

Press and hold the FAV1 or FAV2 button for 5 seconds. During the time that the FAV1 or FAV2 buttons are being held, the system will constantly take pitch and roll measurements. When the FAV1 or FAV2 button is released, the system

will store the average pitch and roll positions that were measured while the FAV button was held. The system will immediately begin automatic control and try to maintain the vessel at the stored position by adjusting the trim tabs.

To activate either FAV setting, simply tap either button as desired. For more information, see the "Using Automatic Operating Modes" section on page 29.

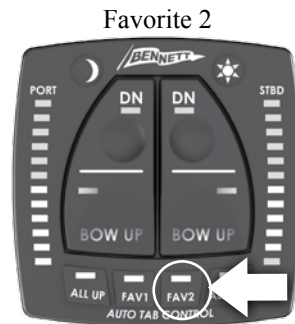
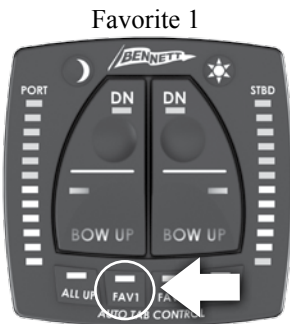



# System Set Up: Auto Mode (Favorites) Set-up



---

# Trim Tab Basics

---

# Trim Tab Basics

This section is intended to provide a general overview of how trim tabs work. For detailed information on operating your AutoTrim Pro, see page 24.

Bennett trim tabs most often attach to the bottom edge of the transom (although other mounting variations are available). When the Helm Display is pressed, the trim tabs move into position. Water-force on the trim tab creates upward pressure, raising the stern and lowering the bow. Properly sized trim tabs improve the performance of your boat in a wide range of weight, weather and water conditions.

In general, trim tabs operate in reverse of what you may think (Figure 1). The port (left) trim tab controls the starboard (right) bow. Conversely, the starboard (right) trim tab controls the port (left) bow. When operating your trim tabs manually, the Helm Display is wired so that all you have to do is press the control in the direction you want the bow to move. Don't worry about which trim tab is moving. The proper use of Bennett Trim Tabs becomes second nature after a short time. **For information about operating ATP auto mode, see page 24.**

Figure 1

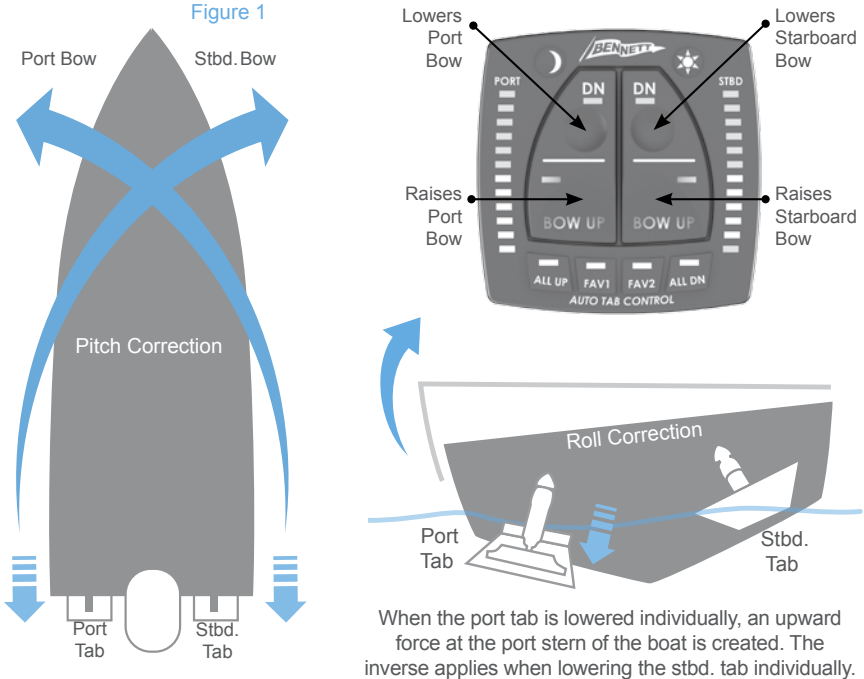

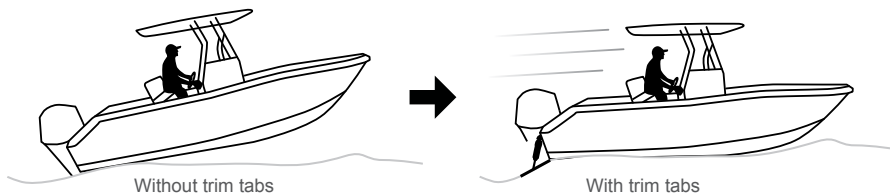

## Getting and staying trimmed

Most boats break over (get on plane) at a particular speed. This speed is determined by weight distribution, and water conditions, etc.. Bennett's trim tabs enable your boat to plane at speeds lower than the natural planing speed. When tabs are deployed, your stern will rise and lower your bow, getting you up on plane faster.

## Optimum Attitude

A good way to find your boat's optimum attitude is to conduct this test: run the boat lightly loaded, at full speed on flat water. Notice the bow in relation to the horizon. This should be your boat's best running attitude. Properly sized trim tabs can be used to recreate this optimum attitude regardless of weight distribution, speed or water conditions.

## Getting Used to the Feel of Your Trim Tabs

When learning to use your tabs manually, begin by pressing the Helm Display in half-second bursts for gradual trimming. Be careful not to over-trim your boat. An over-trimmed boat will plow or bow-steer. If you over-trim the boat, simply press BOW UP and the bow of the boat will rise. **For information about operating ATP auto mode, see page 24.**

This section is intended to provide a general overview of how trim tabs work. For detailed information on operating your AutoTrim Pro, see page 24.

## Special Conditions & Safety Precautions

### Correcting for a List

Bennett Trim Tabs may be operated individually so that you can correct for listing. Your control is designed so that you can use it intuitively. Do not think about what the trim tabs are doing, just concentrate on the bow. If the port bow is high, push the port side BOW DOWN direction. If the starboard bow is high, push the starboard side BOW DOWN direction. Press the control in half-second bursts to avoid over-trimming, allowing time between corrections for the boat to react. **For information about operating ATP auto mode, see page 29.**

### Using In Conjunction With Outboard Trim/Tilt

Using your trim tabs in conjunction with your engine's power trim will give you increased speed and power.

1. Adjust the trim tabs to achieve a planing attitude.
2. Use the power trim to position the prop path parallel to the water flow as indicated by increased RPM / Speed.
3. If necessary, re-adjust the trim tabs to fine tune the trim of your boat.  
In other words, use your trim tabs to trim the boat and your power trim to trim your prop.

### Running In Rough Water

When running in a chop or heavy seas, press BOW DOWN on both tabs. This will bring the "V" of the hull in contact with the waves rather than having the waves pound the hull and your passengers.

### Following Sea

For maximum control and maneuverability in a following sea or when running in an inlet, make sure the trim tabs are fully retracted by pressing BOW UP on both tabs. This brings up the tabs, decreasing lift in the stern, allowing the bow to rise. If tabs are deployed, the bow may dig.

This section is intended to provide a general overview of how trim tabs work. For detailed information on operating your AutoTrim Pro, see page 24.

## **Windy Chop**

To raise the windward side of the boat press BOW UP on that side. If this is not sufficient, press BOW DOWN on the leeward side of the boat. This allows the windward side of the boat to rise and minimizes spray. Do not over-trim when attempting this.

## **Shallow Water / Hole Shot**

To lift the stern and lower the bow, lower both tabs completely down by pressing BOW DOWN on both tabs. As you throttle up and speed increases, raise the tabs by pressing BOW UP on both tabs.

## **Porpoising**

Porpoising is a condition more common in faster boats. As speed increases, the bow repeatedly rises out of the water until gravity overcomes lift and the bow falls down. Press “Bow Down” in half-second bursts. As the trim tabs deflect, the porpoising subsides and your speed should remain the same or decrease. Only a slight amount of trim tab deflection should be necessary.

## **Safety Precautions**

Bennett trim tabs have a significant effect on the operation and versatility of your boat. No one knows your boat better than you, so the best learning method is to spend time getting familiar with your boat’s reaction to the trim tabs.

Remember, practice makes perfect! As your experience increases, so will your enjoyment. Always operate your boat with safety first in mind.

- Do not over-trim, particularly at high speeds as the bow will dig in and wave action may cause the boat to veer.
- While operating trim tabs, use caution. Improper use of trim tabs may cause accidents and/or injury.
- For best maneuverability, trim tabs should be fully retracted in a following sea, or when running in an inlet.

**For information about operating ATP auto mode, see page 24.**

# The ATP Helm Display Quickstart Guide

## Button & LED Indication Overview

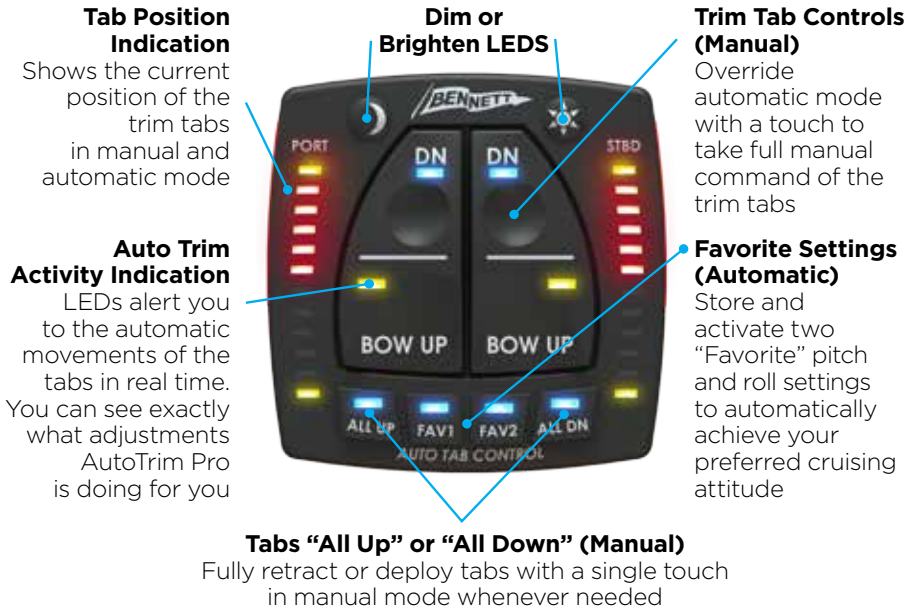

## The ATP Helm Display

The ATP Helm Display is the user interface for the AutoTrim Pro system. There may be one or more ATP Helm Displays installed on the boat depending on the number of control stations in the vessel (Helm station and fly bridge station). The ATP Helm Display integrates four basic control features:

1. Trim Tab Position Display
2. Manual Trim Tab Controls
3. Automatic Trim Tab Controls
4. All Up & All Down Semi-Automatic Controls



# Indication & Manual Mode Buttons

## Yellow LED Indication



These LEDs represent the range of motion that the trim tabs may move through. The four yellow LEDs will be illuminated continuously during normal operation. If one of the upper yellow LEDs is flashing, this is an indication to the user that the system is not receiving a signal from one of the actuator sensors.

deflection. All red LEDs illuminated indicates that the tabs are fully deployed (down).

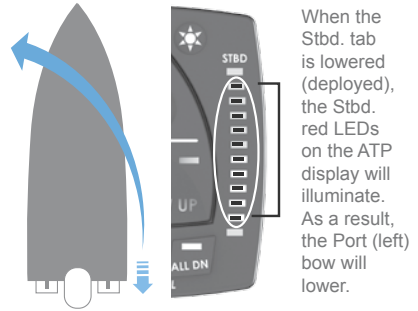

No red LEDs illuminated indicates that the tabs are fully retracted (up). If the red LEDs are flashing, the system does not have a calibration stored for the position display. See page 14 for calibration instructions.

## Red LED Indication

When the Port tab is lowered (deployed), the Port red LEDs on the ATP display will illuminate. As a result, the Stbd. (right) bow will lower.

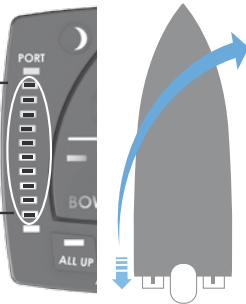

The red LEDs represent the actual movement of the tabs. As the tabs move from the full-up position to the full-down position the red LEDs will illuminate to illustrate the trim tab

## Sun & Moon Buttons

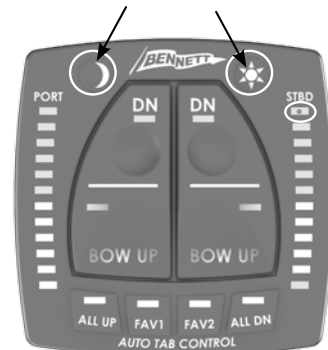

The Sun and moon buttons are used to increase and decrease the brightness of the LEDs on the display.

# Manual Mode Buttons & Indication continued

The Sun and Moon buttons are also used in different sequences to enter calibration modes and set up mode.

## Manual Trim Tab Buttons

The manual trim tab buttons can be used to manually lower and raise the trim tabs, immediately disengaging automatic controls.

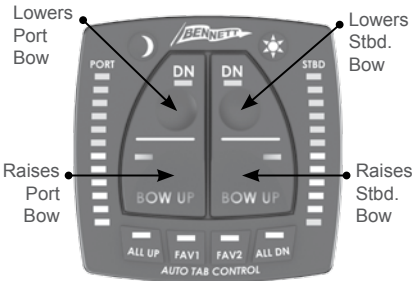

Although the manual mode buttons are intuitive and self-explanatory, the movement of the trim tabs operate in reverse of what you may think,

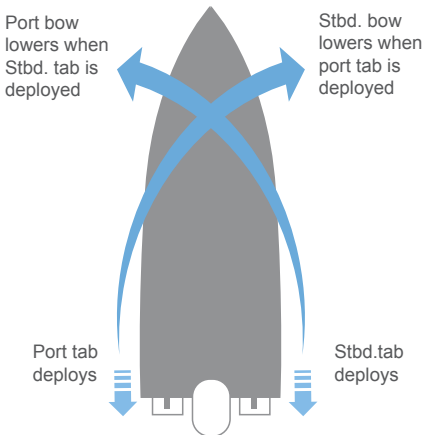

meaning the port (left) trim tab controls the starboard (right) bow. Conversely, the starboard (right) trim tab controls the port (left) bow.

### Upper right button “DN”

(STBD Bow DN) Pressing this button will cause the PORT tab to go down. When the PORT tab is extended, the Starboard bow will be lowered.

### Upper left button “DN”

(Port Bow DN) Pressing this button will cause the Stbd. tab to go down. When the Stbd. tab is extended, the PORT bow will be lowered.

### Lower Right “BOW UP” Button

(STBD Bow UP) Pressing this button will cause the PORT tab to come up. When the PORT tab is retracted, the Starboard bow will be raised.

### Lower Left “BOW UP” Button

(PORT Bow UP) Pressing this button will cause the STBD tab to come up. When the STBD tab is retracted, the PORT bow will be raised.

*See page "Trim Tab Basics" on page 20 for additional information on how the movement of trim tabs affects the pitch and roll of your boat.*

*Continue on to the next section for information on automatic and semi-automatic features.*

# Semi-Automatic Controls

The ATP Helm Display features two convenient buttons enabling boaters to fully retract (raise), or fully deploy (lower) both trim tabs with one quick touch of a button.

- **“ALL UP” Button:** Pressing this button will cause both tabs to fully retract.
- **“ALL DN” Button:** Pressing this button will cause both tabs to fully deploy.

## Using the “All DN” Button

When the ALL DN button is pressed the ATP controller will fully deploy the trim tabs. The ATP controller will monitor the position of the trim tabs and keep trying to put them fully down until the tabs have reached the full-down position.

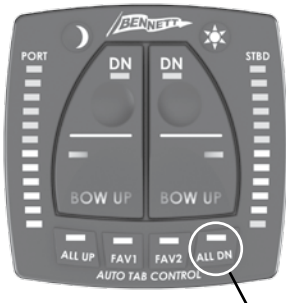

Fully Deploys (Lowers) Both Tabs

The ALL DN button provides a quick and easy way to put the tabs fully down if the tabs are being used in a manual mode.

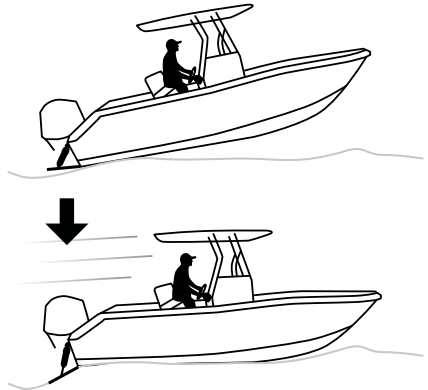

## ⚠ CAUTION

The ALL DN Button will move the trim tabs to the full-down position. This can have a dramatic effect on the attitude of the vessel as both tabs are deployed. The tabs will deploy at the same speed, so it is normal for the tab that was deployed further to reach its limit first. If the boat is underway, the boat may react by a sudden decrease in speed, or listing as the tabs are brought into a full-down position.

Use care when operating a vessel with the trim tabs in a full-down position. In some boats tabs in a full down condition can make the vessel subject to bow steering at medium to high speeds. Tabs should be brought back up for high speed operation.

## Using the “All UP” Button

When the ALL UP button is pressed the ATP controller will fully retract the trim tabs. The ATP controller will



Fully Retracts (Raises) Both Tabs

monitor the position of the trim tabs and keep trying to retract the tabs until the tabs have reached the full-up position. The ALL UP button provides a quick and easy way to bring the tabs full up if the tabs are being used in a manual mode. It is normal for the user to retract the trim tabs immediately after getting the boat on plane.

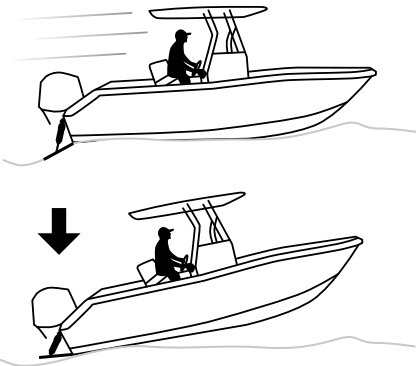

## ⚠ CAUTION

The ALL UP Button will bring the trim tabs to the full-up position. This can have a dramatic effect on the attitude of the vessel as both tabs are retracted.

The Tabs will retract at the same speed, so it is normal for the tab that was deployed further to retract slower. The boat may react by increasing speed, or listing as the tabs are brought to a full-up position.



Sets Favorite Position 1

Sets Favorite Position 2

# Using Automatic Modes

## The Favorite (FAV) Buttons

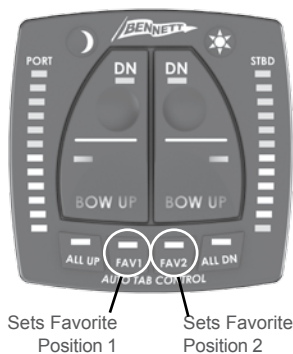

The ATP controller allows for the user to set two different favorite positions. These positions are a combination of pitch and roll attitudes that the user feels are comfortable or useful running attitudes for the boat.

One favorite position may be set such that the boat's roll attitude is level and the pitch attitude is relatively flat.

This is a normal operating condition. In automatic mode, the ATP will operate the trim tabs to attempt to maintain this attitude as speed, engine RPM and weight distribution changes occur. A second favorite position may be set with the port bow high to minimize spray in windy conditions for example.

**“FAV 1” Button:** Will activate the first stored favorite position.

Pressing any manual button, or the ALL UP or ALL DN will cause the ATP system to stop automatic control.

**“FAV 2” Button:** Will activate the second stored favorite position. Pressing any manual button, or the ALL UP or ALL DN will cause the ATP system to stop automatic control.

## Setting a Favorite Position (FAV1 or FAV2)

To enter AUTO mode, the user must first set the favorite position. To set the favorite position:

1. The user will manually adjust the trim tabs, throttle, and engine trim to attain the desired boat attitude.
2. After the desired attitude is set, the user will press and hold the FAV1 or FAV2 button to store the position. The FAV1 or FAV2 button must be pressed for at least three seconds to record the position. If the FAV1 or FAV2 buttons are pressed and held longer, the system will continue to monitor the boat's attitude during the time that the button is held then take an average of the position during that time. This is useful when the conditions are somewhat rough and the vessel is moving around during the time that the position is being set.

# Using Automatic Modes continued

3. After the user releases the FAV1 or FAV2 button, the system will immediately go into automatic operation. When the ATP is in automatic mode, the FAV1 or FAV2 button that was pressed will illuminate with a blue LED to indicate that the unit is in automatic mode and trying to adjust the vessel to the position stored in the corresponding button. Automatic operation is described below. If the user attempts to go into automatic mode and there is no position stored, the FAV1 or FAV2 button that was pressed will flash a yellow LED. No automatic operation will be performed.

## Starting Auto Mode

To start automatic trim tab operations, press and release the FAV1 or FAV2 button. In order to

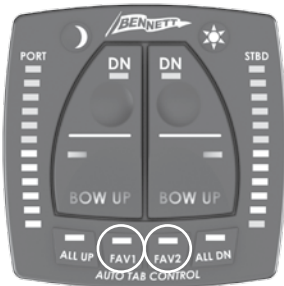

start automatic operations, the unit must have the FAV position set (see "Setting a Favorite Position" on page

29), and it must have the three set-up angles saved (See "Angle Set-up" described on pg. 14).

## **⚠ CAUTION**

Pressing and holding either FAV button will reset to the current position. The ATP will then try to maintain the boat in the new current position.

## Exiting Auto Mode

To exit Auto Mode, any manual button can be pressed and the system will stop automatic control and allow the user to control the trim tabs through the Manual Bow Down and Bow UP buttons.



Pressing either ALL UP or ALL DN will also cause the system to come out of automatic mode.

For a detailed explanation of how auto mode works, see the following section "Understanding Automatic Operation".

# Understanding Automatic Operation

The following information is not required reading to operate your AutoTrim Pro in automatic mode. However this section is designed to provide you with an in-depth understanding of how automatic operation will effect your vessel in various states.

## Normal Operating States

The Bennett ATP system utilizes the information about the boat's pitch and roll position to determine the basic operation state that the boat is being used in. The basic state types of use are:

1. Rest
2. Idling
3. Acceleration
4. Planing
5. Turning
6. Deceleration

In normal operation the boat will progress through these basic operation states. The following example shows how a boat may progress through these operating states in normal use.



## ATP Response to Normal Operating States

This section will explain the basic operating states and the ATP system's response to those operating states.

During the set-up phase of the installation, three pitch angles were set that are associated with the vessel. These are the **Rest** angle, the **Idle** angle and the **Planing** angle. The ATP Controller will utilize these angles to help determine the type of operation that the boat is currently being used in. For information on setting these angles, please refer to pg. 14.

The **Rest** angle was set while the boat was still in the water.

The **Idle** angle was set (See pg. 14) with the boat idling at a speed that represents a no-wake zone speed. The **planing** angle was set (See pg. 15) with the boat up on plane and the trim tabs down.

### Rest Mode



The ATP system will move into the **Rest** mode when the ATP controller senses that the boat is at or below the

**Rest** angle that was set. In this mode the trim tabs will be brought to the full-up position. The ATP will make no attempt to control the attitude of the vessel.

### Idle Mode



The ATP system will move into the **Idle** mode when the ATP controller senses that the boat is at or below the **Idle** angle that was set. In this mode the trim tabs will be brought to the full-up position. The ATP will make no attempt to control the attitude of the vessel while in **Idle** mode as the speed of the vessel is too low to have any meaningful effect on the trim tabs. The ATP system will automatically look for the vessel to move into the **Idle** mode when it detects a deceleration.

### Acceleration Mode

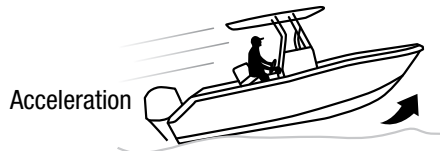

The ATP system will automatically move into **Accel** mode when the ATP Controller senses an acceleration



AND an increase in the pitch angle past the **Planing** angle that was set. In the **Accel** mode, the trim tabs will be fully deployed to assist the vessel with getting on to plane, then move the trim tabs to the anticipated operating position (the position that the trim tabs were at when the FAV position was set). The ATP will wait for a few seconds for the vessel to settle, then it will begin to automatically transition into a **Planing** Mode where the ATP will automatically control the trim tabs to attempt to move the vessel to the FAV position that was set.

### Planing Mode



**Planing** Mode is a relatively steady state condition where the ATP will attempt to maintain the attitude of the vessel at the preset FAV attitude by moving trim tabs. In this mode the ATP will correct roll and pitch changes. It is important to keep in mind that the ATP control cannot make the trim tabs do anything that the user could not do in manual mode. If it is not possible for the trim tabs to adjust the boat's attitude based on the current speed, loading and water conditions, then the ATP

will not be able to make the trim tabs improve performance. If the trim tabs do not have enough effect on the vessel, please call Bennett Marine or your dealer to discuss options that may improve the performance of the trim tabs system.

The ATP system has been designed to mimic what an operator would do. During normal operation, the boat will roll and pitch in response to waves. The boat operator ignores these normal movements and does not try to adjust for these momentary conditions by altering the position of the trim tabs. The boat operator will use the trim tabs to adjust for weight shifts, loading conditions, or throttle positions. The ATP system will work the same way. The ATP will ignore roll and pitch conditions caused by the boat rocking and pitching in the water, and look for longer term average movements. The ATP will attempt to correct for these long term conditions.

### Turning Mode (Lockout)



While the vessel is operating in **planing** mode, it is normal for the boat to be turned as the operator navigates a desired course. As a boat turns, the changing water flow under

the vessel will cause the pitch and roll attitude of the vessel to change while the boat is in a turn. As soon as the vessel exits the turn, the boat's attitude will return to normal. Turns during operation of a boat are a very temporary condition. For this reason the ATP controller will sense that the

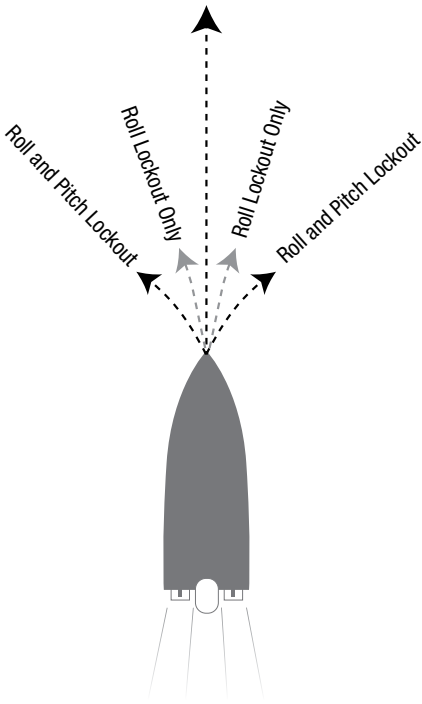

boat is in a turn and modify the way that it tries to adjust. If the turn is fairly gradual (less than 1 degree per second) the ATP control will still make adjustments to the boat to compensate for pitch changes. These pitch changes are uniform on both tabs. If the turn is more than just

gradual (more than 1 degree per second) the ATP controller will sense the turn, and cease trying to make adjustments while the boat is in a turning mode. Turns in a boat are almost always a temporary condition, so the ATP will allow for this temporary condition, and return to automatic control after the boat is back to normal operating conditions. After a turn the ATP control will wait four seconds to allow the vessel to settle before attempting to begin automatic control again.

## Deceleration Mode



The ATP will sense a deceleration and the associated bow rise as a boat is decelerating and coming off plane. The ATP controller will fully deploy the trim tabs when it senses this condition to minimize the amount of bow rise associated with the deceleration. The ATP Controller will then look for the vessel to enter **Idle** mode as the boat slows. The ATP controller will automatically raise the trim tabs to a full-up position as it sees the boat's attitude move into **Idle** mode. As soon as the ATP system senses the deceleration and puts the tabs down, the system will stop all automatic adjustments, as trim tabs

will have no effect on the vessel as the boat is moving slowly.

### Special Conditions

**Hole Shot:** A hole shot is a special condition where the boat operator wants to get the boat up and on plane as quickly as possible. The ATP will sense the boat's acceleration and bow rise and deploy the tabs automatically, but the user can put the



tabs full down before the acceleration begins by putting the vessel in hole shot mode.

To enter Hole Shot Mode:

1. Press the ALL DN button to fully deploy the tabs.
2. As the tabs are moving down, the operator will press the FAV1 or FAV2 button that is desired.

The system will now leave the tabs full down until the vessel is accelerated. This will help the vessel get on plane faster than it would when the tabs are deployed as the vessel is accelerating. When in hole shot mode, the ATP will leave the tabs down until the boat's attitude

moves below the planing angle, then the boat will enter ACCEL mode and move the trim tabs to the anticipated operating position as the vessel gets up on plane. In ACCEL mode, the ATP will wait four seconds for the vessel to settle, then it will move to planing mode.

**Rough Seas:** Rough seas are a special condition where the boat is pitching and rolling excessively due to sea conditions. In rough sea conditions, it is best if the operator takes control of the trim system. The ATP system is constantly monitoring sea conditions for large swings in pitch and roll, as well as excessive pounding from waves. Upon detecting rough sea conditions, the ATP control will stop automatic trim tab operations and fully retract the trim tabs. The ATP control will indicate that the system has detected rough seas by flashing the blue lights on the FAV1 and FAV2 buttons. The lights will continue to flash until sea conditions have changed. When the ATP senses that the sea conditions are calmer, the ATP will again resume normal operation.



These two LEDs will flash alternately to indicate the system senses rough sea conditions.

# Troubleshooting

## Installation & Start Up

### ATP Helm Display not illuminating

As soon as power and ground are connected to the ATP display, the display will flash the LEDs, starting from the outside corners and moving toward the center. If LEDs are not seen flashing when power is applied, no power is supplied to the ATP Display.

- **Potential Cause 1:** No power to the ATP Helm Display orange wire
  - **Solution:** Check for power connection to the ATP Helm Display to ensure it is turned ON. This should normally be the same power source as the helm instrumentation
- **Potential Cause 2:** No Ground connection to the ATP Helm Display black wire
  - **Solution:** Check for ground connection
- **Potential Cause 3:** ATP Helm Display has been dimmed to off position.
  - **Solution:** Press the SUN button several times to brighten the display
- **Potential Cause 4:** Fuse blown on the ATP Helm Display
  - **Solution:** Check fuse at ATP Helm Display. Fuse should be 1.5A

### ATP Helm Display illuminates on power-up but then goes dark

The ATP Helm Display will turn off when there is no communications between the ATP Helm Display and the ATP Control Unit.

- **Potential Cause 1:** The ATP Control Unit has no power applied to it.
  - **Solution:** Verify that the red Power LED in the lower center of the ATP Control Unit is illuminated. If it is not illuminated, check the power supplied to the orange and black wires of the ATP Control Unit.
- **Potential Cause 2:** No communications between the ATP Helm Display and the Control Unit.
  - **Solution a:** Verify that the ATP display communications LED is flashing. This is the lower left LED on the ATP Control Unit. If this LED is not flashing, there is no communications between the ATP Helm Display and the ATP Control Unit.
  - **Solution b:** Verify that the ATP display communications cable is connected to the communications cable on the ATP Control Unit . An extension cable may be used

between the ATP display and the ATP Control Unit. This cable should be a thin gray cable with a four position connector.

- **Solution c:** Unplug the ATP display communications cable and inspect the pins inside the connector. If a pin has been pushed back, remove the orange retainer, push the pin forward until it clicks, then replace the orange retainer.

### **ATP Helm Display has the two blue LEDs above the FAV1 and FAV2 buttons flashing**

The ATP Helm Display will flash the blue LEDs above the FAV1 and FAV2 buttons when the ATP Control Unit has not been oriented to the boat. This is normal as the system is shipped without an orientation configuration. The orientation must be performed with the boat in the water, and the system completely functional

- **Potential Cause:** The ATP system has not been oriented following the ATP Control Unit installation
  - **Solution:** Verify that the trim tabs function properly when the manual buttons are pressed. Follow the Orientation procedure on page 14.

### **Tabs do not retract when ignition is turned off**

- **Potential Cause:** System is not wired to a power source that shuts off when the ignition is turned off
  - **Solution:** Re-wire to power source that shuts off with the ignition. Connect the purple wire from the back of the display to a power source that is shut off by the ignition.

### **Display LEDs do not go off when the ignition is turned off**

- **Potential Cause:** System is not wired to a power source that shuts off when the ignition is turned off
  - **Solution:** Re-wire to power source that shuts off with the ignition. Connect the orange wire from the back of the display to a power source that is shut off by the ignition

### **Trim Tabs not responding when ATP Helm Display buttons are pressed**

- **Potential Cause 1:** No communications between the ATP Helm Display and the Control Unit.
  - **Solution a:** Verify that the ATP display communications

LED is flashing. This is the lower left LED on the ATP Control Unit. If this LED is not flashing, there is no communications between the ATP Helm Display and the ATP Control Unit.

- **Solution b:** Verify that the ATP display communications cable is connected to the communications cable on the ATP Control Unit. An extension cable may be used between the ATP display and the ATP Control Unit. This cable should be a thin gray cable with a four position connector.
- **Solution c:** Unplug the ATP display communications cable and inspect the pins inside the connector. If a pin has been pushed back, remove the orange retainer, push the pin forward until it clicks, then replace the orange retainer.
- **Potential Cause 2:** The ATP Control Unit has no power applied to it.
  - **Solution:** Verify that the red Power LED in the lower center of the ATP Control Unit is illuminated. If it is not illuminated, check the power supplied to the orange and black wires of the ATP Control Unit.

- **Potential Cause 3:** The Actuators are not connected to the ATP Control Unit

- **Solution:** Verify that the blue and yellow cable from the upper right side of the ATP Control Unit is connected to the Starboard (right) actuator cable. Verify that the blue and yellow cable from the lower right side of the ATP Control Unit is connected to the Port (left) actuator cable.

- **Potential Cause 4:** The trim tab system is not functioning properly

- **Solution:** The ATP installation assumes a fully functioning trim tab system is in place before the ATP system is installed. Refer to the Trim tabs owner's manual for full instructions on HPU installation and troubleshooting. Also refer to troubleshooting at [BennettTrimTabs.com](http://BennettTrimTabs.com) or call our support line at (954) 427-1400 M-F 8AM - 5PM EST.

**Operations****FAV button pressed and unit will not go into auto mode**

- **Potential Cause 1:** No FAV position stored

**Solution:** Check for flashing yellow above the FAV1 or FAV2 buttons as the FAV button is pressed. This is an indication that there is no position stored in the FAV button that has been pressed. To store a position, manually adjust the boat into the desired attitude using the throttle, engine trim and trim tabs. Press and hold the FAV button. Button must be held for at least three seconds. The ATP will go to automatic control mode as soon as the button is released.

- **Potential Cause 2:** Orientation not completed

**Solution:** Follow the orientation procedure on page 14.

- **Potential Cause 3:** Angle Set-Up Not completed
  - **Solution:** Follow the Set-Up procedure in page 14.

**ATP Helm Display has the two blue LEDs above the FAV1 and FAV2 buttons flashing**

The ATP Helm Display will flash the blue LEDs above the FAV1 and FAV2 buttons when the ATP Control Unit has not been oriented to the boat. This is normal as the system is shipped without an orientation configuration. The orientation must be performed with the boat in the water, and the system completely functional

- **Potential Cause:** The ATP system has not been oriented following the ATP Control Unit installation
  - **Solution:** Verify that the trim tabs function properly when the manual buttons are pressed. Follow the Orientation procedure on page 14.

**No response from ALL Up Button**

- **Potential Cause:** Tabs are already in full-up position.
  - **Solution:** System is working as designed

**No Response from ALL DN Button**

- **Potential Cause:** Tabs are already in full-down position.
  - **Solution:** System is working as designed

## System comes out of FAV mode

- **Potential Cause 1:** A manual trim tab button, ALL Up or ALL Down has been pressed
  - **Solution:** System is working as designed. Pressing any button will cause the system to exit automatic operation.
- **Potential Cause 2:** System has detected rough sea conditions
  - **Solution:** If the system flashes the blue LEDs above the FAV1 and FAV2 buttons and the stops automatic operation, the system is working as designed. The system will constantly monitor conditions and when the system detects excessive roll conditions or excessive pounding, the system will retract the tabs and exit automatic mode. Under these kinds of conditions, the user must operate the trim tabs manually.
- **Potential Cause 3:** Intermittent power has caused the system to brown out and restart.
  - **Solution:** Verify the power connections to the ATP Helm Display and the ATP Control Unit. If there is a temporary power outage the system will shut down and restart.

After each restart the ATP Helm Display will flash all the LEDs starting in the outside corners and moving toward the center. Rewire the system such that the power source for the ATP display is a clean, stable source not affected by voltage drops when large loads are operated.

## System brings tabs full up and will not auto control

- **Potential Cause:** System has detected rough sea conditions
  - **Solution:** If the system flashes the blue LEDs above the FAV1 and FAV2 buttons and the stops automatic operation, the system is working as designed. The system will constantly monitor conditions and when the system detects excessive roll conditions or excessive pounding, the system will retract the tabs and exit automatic mode. Under these kinds of conditions, the user must operate the trim tabs manually.

## System tries to maintain a position that is not the position that was set

- **Potential Cause 1:** Position has been accidentally reset by



pressing and holding the FAV1 or FAV2 buttons too long

- **Solution:** Reset the FAV1 or FAV2 position. Manually adjust the boat to the desired position. Press & hold the AV1 or FAV2 buttons to store the desired position. See page 29 for more details.
- **Potential Cause 2:** The trim tab system is not capable of moving the boat to the desired position
  - **Solution:** Verify that the user can manually adjust the trim tab system to move the boat to the desired position at the same load, engine RPM, and engine tilt settings. If the trim tab system cannot adjust the boat under manual operation, it will not be able to adjust it under automatic operation.

### **ATP will not Control boat attitude**

- **Potential Cause 1:** Actuators plumbed or wired backwards
  - **Solution:** Verify that when in manual mode that pressing the upper left manual control button causes the right (Starboard) tab to go down. Verify that when in manual mode that pressing the upper right manual control button

causes the left (port) tab to go down. Verify that when in manual mode that pressing the upper left manual control button causes the right (stbd) tab to go down.

- **Potential Cause 2:** ATP Control Unit not installed in a good location
  - **Solution:** The ATP Control Unit must be installed on a rigid, non-moving surface, away from any magnetic objects. Move the ATP Control Unit to a more suitable location (See pg. 8), then repeat the set-up and orientation procedures.
- **Potential Cause 3:** ATP Control Unit orientation not correct
  - **Solution:** The ATP Control Unit must be oriented to the boat. If the orientation is reset while the boat is in the wrong position, the ATP will not properly control the boat. To reset the orientation, follow the orientation procedure in page 11

### **System will not automatically retract tabs when boat is idling or at rest**

- **Potential Cause:** Idle Angle is set too low.

- **Solution:** The boat is not settling below the idle angle so the tabs are not being retracted. Reset the idle angle with the boat at a slower speed when the idle angle is set. Do not set the idle angle with a heavily loaded bow.

## System will not automatically deploy the tabs on acceleration

- **Potential Cause 1:** Idle Angle is set too low.
  - **Solution:** The boat is not settling below the idle angle so the tabs are not being retracted. When the system does not detect a settling and a full tab retraction, it assumes the system is still in planning mode. The system will not fully deploy the tabs on acceleration to prevent false full tab deployment. Reset the idle angle with the boat at a slower speed when the idle angle is set. Do not set the idle angle with a heavily loaded bow.
- **Potential Cause 2:** Slow Acceleration
  - **Solution:** The system detects accelerations to determine that the boat needs to put the tabs down. If the boat is accelerated very

slowly, the system may not detect the acceleration. As the bow rises, the system will go into automatic control mode and put the tabs down in a control mode, but it will not rapidly deploy the tabs. If the boat is accelerated slightly faster, the acceleration may be sufficient to be detected and drive the tabs down.

## System retracts the tabs at high speeds

- **Potential Cause 1:** Planning Angle decreased below the idle angle.
  - **Solution:** If the boat is moving fast and slightly bow heavy, the boat can attain a planning attitude that is below the angle that the boat might idle at. In this case, the system thinks that the boat is moving slow, so it retracts the tabs. This situation can be changed by resetting the planning angle at a lower angle. Use a higher speed and additional tab deployment when resetting the planning angle.
- **Potential Cause 2:** Operating speed of the boat naturally drives the hull below the FAV position.
  - **Solution:** If the boat is moving fast and the FAV

position is set a relatively low speed, as the boat speed increases, the bow angle will naturally decrease. The system will recognize that the bow is low and try to bring the tabs up to compensate. Once the tabs are full up, the tabs no longer have any effect on the bow

angle. The tabs cannot raise the bow to achieve the FAV position. Use the engine trim to raise the bow and the boat will come back into the operating range where the trim tabs are effective.



# Bennett Marine Warranty

We at Bennett Marine, (Bennett) are committed to product quality and customer satisfaction. We've supported our products for more than half a century and have earned a reputation for exceptional service and support. In keeping with that tradition Bennett provides a Limited Warranty for its Products. Please see the table below for our Warranty details.

## Disclaimer And Exclusion Of

**Warranties:** This warranty is meant to be a complete and exclusive statement of the terms of all express warranties offered by Bennett. To the extent permitted by law, there are no warranties, express or implied, including any implied warranties of merchantability or fitness for a particular purpose extended by Bennett other than the express warranty set forth in this instrument. Some states do not allow the exclusion of, or limitations to, implied warranties so the above limitation may not apply to you.

**Warranty Claim Procedure:** To make a claim please call Bennett Marine at 954-427-1400 to troubleshoot the issue and start the claim process. You will be asked to complete a form that can be found online at [BennettTrimTabs.com/Warranty](http://BennettTrimTabs.com/Warranty) and return the part for warranty evaluation. Parts will be evaluated upon receipt and any part found to meet the above warranty criteria will be repaired or replaced at Bennett's option. Replacement or repaired part, will be shipped at no cost to customer via ground freight to US destinations only. Any expedite methods will be at customer's expense.

**Transferability:** Before expiration of the warranty period, this Limited Warranty is fully transferable to subsequent owners of the boat on which it is originally installed and is void if the product is removed and reinstalled on another boat or is used for purposes for which it was not originally purchased.

## Limitation And Exclusion Of Remedies:

Bennett's sole responsibility shall be the repair or replacement, at its option, of any defective part or component. In certain instances Bennett reserves the right to provide refurbished parts. Customer agrees that this is the sole and exclusive remedy under this Limited Warranty. Bennett will not be responsible for any incidental, consequential or indirect damages, including loss of use as a result of any manufacturing defect in a product. Bennett will not be responsible for labor, haul out, or any other fees associated with the removal or installation of warranted parts. Some states do not allow the exclusion or limitation of incidental or consequential damages, so this limitation may not apply to you.

**Product modification:** Bennett reserves the right to change, modify or improve the products without obligation to incorporate such changes in products previously sold or installed. With respect to components or products replaced under this warranty, Bennett Marine reserves the right, in its sole discretion, to provide updated or current model components or products.

## Return Procedure For Customers

**Outside Us:** For international returns, please refer to our worldwide distributor map on our website [BennettTrimTabs.com/find-a-dealer](http://BennettTrimTabs.com/find-a-dealer) to contact your local Bennett Marine distributor for warranty and returns procedures in your respective country.

Product	Warranty Period
AutoTrim Pro Helm Display	3 years
AutoTrim Pro Control Unit	3 years







**BENNETT MARINE**



**Bennett Marine, Inc.**

550 Jim Moran Boulevard, Deerfield Beach, FL 33442, USA



**954-427-1400**

M-F 8am to 5pm (EST)



[BennettTrimTabs.com](http://BennettTrimTabs.com)



[Info@BennettTrimTabs.com](mailto:Info@BennettTrimTabs.com)

**FAX**

954-480-2897

**Get Bennett On Board, And Enjoy The Ride**